

ACCESSORIES AND REPLACEMENT COMPONENTS

OIL SEPARATOR COMPONENTS

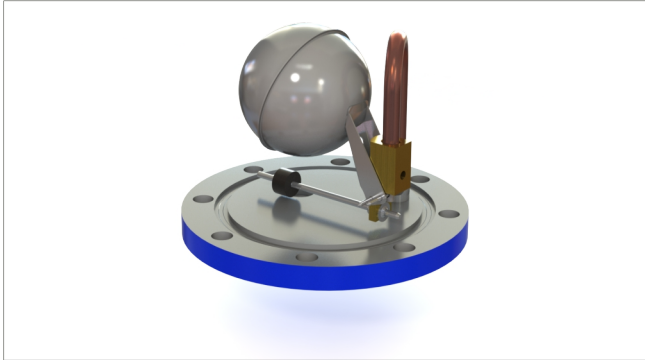

Henry Technologies offers various replacement components for the oil separators. After an extended service life, they may need to be replaced due to wear and the collection of system debris with the small flow orifices.

The below chart shows all the available replacement parts for Henry Technologies' Oil Separators.

Vessel Part No	Float Assembly*	Gasket**	Brass Screens***	Filter Cartridge		
S-5290	A-1900-30	2-023-001	N/A	N/A		
S-5292						
S-5294						
S-5202						
S-5203						
S-5204						
S-1901						
S-1902						
S-1903						
S-1904						
S-5792	A-5700-30	N/A	N/A	3-010-301		
S-5794						
S-5882	A-5000-30					
S-5885						
S-5887						
S-5888						
S-5890						
COSM-030	N/A			2-023-087	N/A	2-043-056
COSM-070				2-023-088		2-043-055
COSM-140				2-023-089		2-043-054
COSM-205		2-023-089	2-043-070			
COSM-250		2-023-119	2-043-071			

*Float assemblies available with optional 3/8" ODS oil return connection by ordering with and "x" suffix (i.e. A-1900-30X)
 **Gasket included with replacement float assembly
 ***Replacement screens are difficult to replace

EXTERNAL OIL FLOAT



Henry Technologies offers the SN-9142 External Oil Float as an optional accessory for Oil Management Systems. The SN-9142 is suitable for use with ammonia, HCFC and HFC refrigerants and their associated oils, as well as other industrial fluids non-corrosive to steel. The 7771 Shut-Off Valve can be used on the float outlet to allow oil return line isolation.

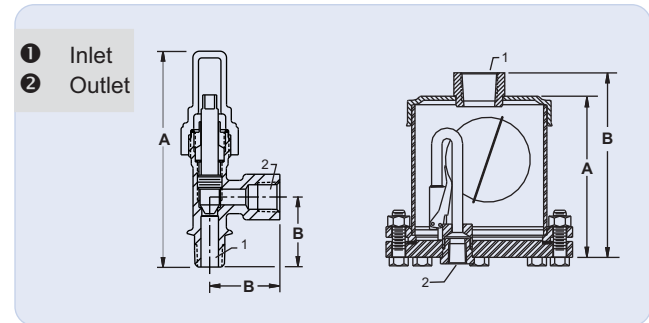

Part No	Description	Inlet NPT (inch)	Outlet NPT (inch)	Dimensions (inch)	
				A	B
SN-9142	Oil Float Valve	3/4	1/4	4.75	5.44
SN-9140-30	Replacement Float	N/A	1/4	N/A	N/A
7771	Shut-Off Valve	1/4	1/4	3.85	1.25

SIGHT GLASS COMPONENTS

3-BOLT SIGHT GLASSES

① 3 Bolt 1-7/8" BC

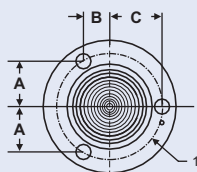

FIG 1

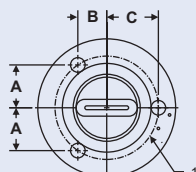

FIG 2

Part No	Fig No	Dimensions (inch)		
		A	B	C
2-020-006	1	0.777	0.524	0.937
SG-1300	2	0.777	0.524	0.937

Applications

Henry Technologies offers two styles of 3-bolt Sight Glasses for use on compressor crankcases or Mechanical and Electro-Mechanical Oil Level Regulators. The Sight Glasses are available with a Reflex Lens or a Prism Lens. The Reflex Lens is designed to allow easier fluid level inspection by appearing dark when liquid is present and light when liquid is absent. Similarly, the Prism Lens will appear as a bright double line under partial fluid level and completely disappear under full fluid contact.

Henry Technologies' replacement Sight Glasses are suitable for use with ammonia, HFC and HCFC refrigerants and their associated oils, as well as other industrial fluids non-corrosive to steel, glass and synthetic rubber.

Technical Specifications

Maximum working pressure = 500 PSI (34.4 Bar)
Allowable operating temperature = -20°F to +300°F (-29°C to +149°C)

Henry Technologies' Sight Glasses are USR and CNR recognized by Underwriters Laboratories, Inc.

Materials of Construction

All Sight Glasses feature a plated steel body with hermetically sealed soda lime glass lens.

Installation - Notes

1. Full instructions are given in the Product Instruction Sheet, included with each Sight Glass.

THREADED SIGHT GLASSES

① 1-1/8" - 24 Thread

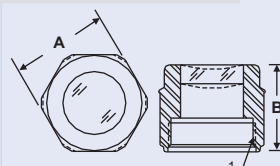

FIG 1

① 1-1/8" - 24 Thread

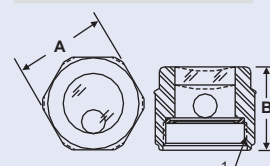

FIG 2

① 1" - 20 Thread

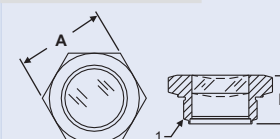

FIG 3

① 1" - 20 Thread

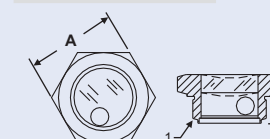

FIG 4

Part No	Fig No	Gasket Part No	Dimensions (inch)	
			A (hex)	B
3-020-052	1	2-023-019	1.25	1.13
3-020-053	2	2-023-019	1.25	1.13
3-020-010	3	2-023-005	1.25	0.67
3-020-011	4	2-023-005	1.25	0.67

Applications

Henry Technologies offers two styles of threaded Sight Glasses for replacement components on Oil Reservoirs and Oil Separator-Reservoirs. The male threaded design was used until May 1988 and the Female threaded design has been used from May 1988 to present. Both designs are currently available as replacement parts.

The Sight Glasses are available with a Clear Lens or Clear Lens with Float Ball. The Clear Lens design allows for unobstructed visual inspection of fluid level. The Float Ball series is designed to provide easier inspection of fluid level. The standard Float Ball is made of TPX plastic and will float in an fluid with a specific gravity greater than 0.85.

Henry Technologies' replacement Sight Glasses are suitable for use with HFC and HCFC refrigerants and their associated oils, as well as other industrial fluids non-corrosive to steel, glass and TPX Plastic.

Technical Specifications

Maximum working pressure = 500 PSI (34.4 Bar)
Allowable operating temperature = -20°F to +300°F (-29°C to +149°C)

Henry Technologies' Sight Glasses are USR and CNR recognized by Underwriters Laboratories, Inc..

Materials of Construction

All Sight Glasses feature a plated steel body with hermetically sealed soda lime glass lens. The Float Balls are made of TPX plastic.